



| Single Phase 1.4 kVA – 36.1 kVA |



The VRP is a highly sophisticated automatic precision AC voltage regulator that ensures maintenance free operation of electronic equipment over a very wide input voltage range.

TSI Power's VRP series is designed to provide high precision power with industry leading response time of one-half line cycle (10 ms or less).

Features and Benefits

Standby operation minimizes interaction with existing loads or power distribution systems, while being compatible with most loads

Wide input range ($\pm 20\%$) and precise output regulation ($\pm 3\%$) provides superior performance.

Various AC input/output connector type wiring terminals facilitate specific applications.

Internal surge protection and noise filtering assures trouble-free operation.

AC input circuit breakers and load over-current protection prevents costly equipment damage.

Customizable for unique and challenging applications.

How the VRP works

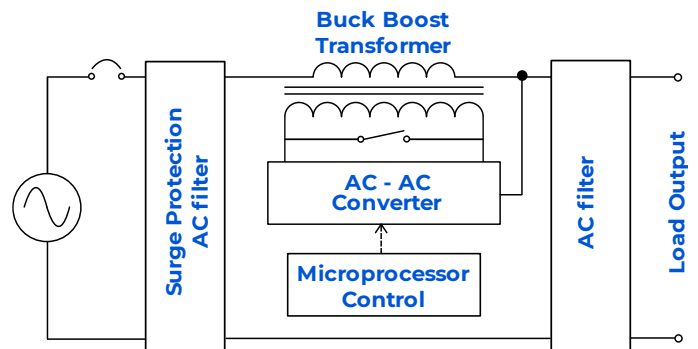

The high frequency Insulated Gate Bi-polar Transistor (IGBT) driven converter takes the incoming AC power, measures it against the nominal voltage reference and adds or subtracts voltage to achieve a precisely regulated output. The automatic bypass will be activated when there is a fault condition. Green LED is used to indicate Normal (regulating mode) operation.

Model Number Selection Guide

VRP--

Rated frequency

Frequency	Suffix
50/60 Hz	A
60 Hz	B

Input / Output wiring connections*

Wiring connection	Suffix
Hard-wired	00
NEMA straight blade	11
NEMA twist-lock	22
IEC 60320	33
Schuko	44
UK	55
Australia/New Zealand	66

Nominal voltage

Voltage	Suffix
120 V	3
208 V	5
220 V	6
230 V	7
240 V	8

Rated capacity in VA (rounded to the nearest hundred)

VA (120 V)	VA (208 V)	VA (220 V)	VA (230 V)	VA (240 V)
1400	1700	1800	1800	1900
1900	2500	2600	2800	2900
2900	3300	3500	3700	3800
4800	5000	5300	5500	5800
7700	6700	7000	7400	7700
9600	8300	8800	9200	9600
18000	13300	12300	14700	15400
	15000	14100	16600	17300
	16700	15800	18400	19200
	31300	17600	34600	36100
		33100		

Example:

Model VRP-2900-300B will have rated capacity of 2900 VA, nominal voltage of 120V, hard-wired input and output connectors, and rated frequency of 60 Hz frequency rating.

***Note 1:** Refer to connector types in Table A for details.

^Note 2: For custom build models, please contact TSI Power. Contact information can be found on the last page of this document.

Technical Specifications*

[120 V, 1440 VA]

Model	VRP-1400-311B	VRP-1400-322B	VRP-1400-333B
Electrical			
Capacity / (VA)	1440		
Design topology	High-performance PWM voltage regulator operating at 20 kHz		
Voltage correction time	8 ms (½ line cycle)		
AC Input			
Input voltage range	120 V ± 20% (96 – 144 V)		
Frequency	60 Hz ± 5 %		
Input circuit breaker rating	15 A		
AC Input connector	NEMA 5-15P	NEMA L5-15P twist-lock	IEC 60320 C14
Surge protection	Three-stage surge protector protects both the VRP and connected equipment from surges & spikes		
AC Output			
Output voltage	120 V ± 3%		
Power efficiency	97% typical (for load of 50 to 100%)		
Maximum rated output current	12.0 A		
System status indicator	Green LED ON-Normal operation - Amber LED ON-Bypass operation Red LED ON-Fault		
Output connector	4x NEMA 5-15R	NEMA L5-15R	IEC 60320 C13
Physical			
Dimension (W x H x D)	12" (305 mm) x 6.2" (158 mm) x 15" (381 mm)		
Weight	32 lbs (14.5 kg)		
Wall / floor mounting kit	MK-4000C		
Max wire size (hard-wired)	Not applicable		
Environmental			
Operating temperature range	32° to +104° F (0° to +40° C)		
Operating humidity range	10 to 90% relative humidity (non-condensing)		
Operating altitude range	0 to 2,000 meters (6,600 ft) above sea level (without derating output power)		
Storage temperature range	-4° to +140° F (-20° to +60°C)		
Safety			
Agency approvals	Designed to meet UL 60950 (UL/cUL listing pending)		
Warranty			
Two-year limited warranty on parts and labor			

*Note: For continuous product improvement, specifications are subject to change without notice.

Technical Specifications*

[120 V, 1920 VA]

Model	VRP-1900-300B	VRP-1900-311B	VRP-1900-322B	VRP-1900-333B
-------	---------------	---------------	---------------	---------------

Electrical

Capacity / (VA)	1920
Design topology	High-performance PWM voltage regulator operating at 20 kHz
Voltage correction time	8 ms (½ line cycle)

AC Input

Input voltage range	120 V ± 20% (96 – 144 V)			
Frequency	60 Hz ± 5 %			
Input Circuit breaker rating	20 A			
AC Input connector	Hard-wired	NEMA 5-20P	NEMA L5-20P	IEC 60320 C20
Surge protection	Three-stage surge protector protects both the VRP and connected equipment from surges & spikes			

AC Output

Output voltage	120 V ± 3%			
Power efficiency	97% typical (for load of 50 to 100%)			
Maximum rated output current	16.0 A			
System status indicator	Green LED ON-Normal operation - Amber LED ON-Bypass operation Red LED ON-Fault			
Output connector	Hard-wired	4x NEMA 5-20R	NEMA L5-20R	IEC 60320 C19

Physical

Dimension (W x H x D)	12" (305 mm) x 6.2" (158 mm) x 15" (381 mm)			
Weight	32 lbs (14.5 kg)			
Wall / floor mounting kit	MK-4000C			
Max wire size (hard-wired)	8 AWG (10 mm ²)	Not applicable		

Environmental

Operating Temperature Range	32° to +104° F (0° to +40° C)			
Operating Humidity Range	10 to 90% relative humidity (non-condensing)			
Operating altitude range	0 to 2,000 meters (6,600 ft) above sea level (without derating output power)			
Storage temperature range	-4° to +140° F (-20° to +60°C)			

Safety

Agency approvals	Designed to meet UL 60950 (UL/cUL listing pending)			
------------------	--	--	--	--

Warranty

Two-year limited warranty on parts and labor

*Note: For continuous product improvement, specifications are subject to change without notice.

Technical Specifications*

[120 V, 2880 VA]

Model	VRP-2900-300B	VRP-2900-311B	VRP2-2900-322B
Electrical			
Capacity / (VA)	2880		
Design topology	High-performance PWM voltage regulator operating at 20 kHz		
Voltage correction time	8 ms (½ line cycle)		
AC Input			
Input voltage range	120 V ± 20% (96 – 144 V)		
Frequency	60 Hz ± 5%		
Input Circuit breaker rating	30 A		
AC Input connector	Hard-wired	NEMA 5-30P	NEMA L5-30P
Surge protection	Three-stage surge protector protects both the VRP and connected equipment from surges & spikes		
AC Output			
Output voltage	120 V ± 3%		
Power efficiency	97% typical (for load of 50 to 100%)		
Maximum rated output current	24.0 A		
System status indicator	Green LED ON-Normal operation - Amber LED ON-Bypass operation Red LED ON-Fault		
Output connector	Hard-wired	NEMA 5-30R	NEMA L5-30R
Physical			
Dimension (W x H x D)	12" (305 mm) x 6.2" (158 mm) x 15" (381 mm)		
Weight	43 lbs (19.5 kg)		
Wall / floor mounting kit	MK-4000C		
Max wire size (hard-wired)	8 AWG (10 mm ²)	Not Applicable	
Environmental			
Operating Temperature Range	32° to +104° F (0° to +40° C)		
Operating Humidity Range	10 to 90% relative humidity (non-condensing)		
Operating altitude range	0 to 2,000 meters (6,600 ft) above sea level (without derating output power)		
Storage temperature range	-4° to +140° F (-20° to +60°C)		
Safety			
Agency approvals	Designed to meet UL 60950 (UL/cUL listing pending)		
Warranty			
Two-year limited warranty on parts and labor			

*Note: For continuous product improvement, specifications are subject to change without notice.

Technical Specifications*

[120 V, 4800 VA]

Model	VRP-4800-300B	VRP-4800-311B
-------	---------------	---------------

Electrical

Capacity / (VA)	4800	
Design topology	High-performance PWM voltage regulator operating at 20 kHz	
Voltage correction time	8 ms (½ line cycle)	

AC Input

Input voltage range	120 V ± 20% (96 – 144 V)	
Frequency	60 Hz ± 5 %	
Input Circuit breaker rating	50 A	
AC Input connector	Hard-wired	NEMA 5-50P
Surge protection	Three-stage surge protector protects both the VRP and connected equipment from surges & spikes	

AC Output

Output voltage	120 V ± 3%	
Power efficiency	97% typical (for load of 50 to 100%)	
Maximum rated output current	40.0 A	
System status indicator	Green LED ON-Normal operation - Amber LED ON-Bypass operation Red LED ON-Fault	
Output connector	Hard-wired	NEMA 5-50R

Physical

Dimension (W x H x D)	12" (305 mm) x 6.2" (158 mm) x 15" (381 mm)	
Weight	47 lbs (21.3 kg)	
Wall / floor mounting kit	MK-4000C	
Max wire size (hard-wired)	8 AWG (10 mm ²)	Not applicable

Environmental

Operating Temperature Range	32° to +104° F (0° to +40° C)	
Operating Humidity Range	10 to 90% relative humidity (non-condensing)	
Operating altitude range	0 to 2,000 meters (6,600 ft) above sea level (without derating output power)	
Storage temperature range	-4° to +140° F (-20° to +60°C)	

Safety

Agency approvals	Designed to meet UL 60950 (UL/cUL listing pending)	
------------------	--	--

Warranty

Two-year limited warranty on parts and labor

*Note: For continuous product improvement, specifications are subject to change without notice.

Technical Specifications*

[120 V, 7680/9600/18000 VA]

Model	VRP-7700-300B	VRP-9600-300B	VRP-18000-300B
-------	---------------	---------------	----------------

Electrical

Capacity / (VA)	7680	9600	18000
Design topology	High-performance PWM voltage regulator operating at 20 kHz		
Voltage correction time	8 ms (½ line cycle)		

AC Input

Input voltage range	120 V ± 20% (96 – 144 V)		
Frequency	60 Hz ± 5 %		
Input Circuit breaker rating	80 A	100 A	None
AC Input connector	Hard-wired		
Surge protection	Three-stage surge protector protects both the VRP and connected equipment from surges & spikes		

AC Output

Output voltage	120 V ± 3%		
Power efficiency	97% typical (for load of 50 to 100%)		
Maximum rated output current	64.0 A	80.0 A	150.0 A
System status indicator	Green LED ON-Normal operation - Amber LED ON-Bypass operation Red LED ON-Fault		
Output connector	Hard-wired		

Physical

Dimension (W x H x D)	14.5" (368 mm) x 8.9" (226 mm) x 19.8" (502 mm)		24.0" (610 mm) x 24.6" (625 mm) x 24.0" (610 mm)
Weight	86 lbs (39 kg)	109 lbs (9.4 kg)	251 lbs (113.9 kg)
Wall / floor mounting kit	MK-8000C		Not applicable
Max wire size (hard-wired)	2 AWG (35 mm ²)	2 AWG (35 mm ²)	4/0 AWG (120 mm ²)

Environmental

Operating Temperature Range	32° to +104° F (0° to +40° C)		
Operating Humidity Range	10 to 90% relative humidity (non-condensing)		
Operating altitude range	0 to 2,000 meters (6,600 ft) above sea level (without derating output power)		
Storage temperature range	-4° to +140° F (-20° to +60°C)		

Safety

Agency approvals	Designed to meet UL 60950 (UL/cUL listing pending)		
------------------	--	--	--

Warranty

Two-year limited warranty on parts and labor

*Note: For continuous product improvement, specifications are subject to change without notice.

Technical Specifications*

[208 V, 1664 VA]

Model	VRP-1700-500A	VRP-1700-533A
Electrical		
Capacity / (VA)	1664	
Design topology	High-performance PWM voltage regulator operating at 20 kHz	
Voltage correction time	8 - 10 ms (½ line cycle)	
AC Input		
Input voltage range	208 V ±20% (166 – 250 V)	
Frequency	50/60 Hz ± 5 %	
Input circuit breaker rating	10 A	
AC Input connector	Hard-wired	IEC 60320 C14
Surge protection	Three-stage surge protector protects both the VRP and connected equipment from surges & spikes	
AC Output		
Output voltage	208 V ± 3%	
Power efficiency	97% typical (for load of 50 to 100%)	
Maximum rated output current	8.0 A	
System status indicator	Green LED ON-Normal operation - Amber LED ON-Bypass operation Red LED ON-Fault	
Output connector	Hard-wired	IEC 60320 C13
Physical		
Dimension (W x H x D)	12" (305 mm) x 6.2" (158 mm) x 15" (381 mm)	
Weight	32 lbs (14.5 kg)	
Wall / floor mounting kit	MK-4000C	
Max wire size (hard-wired)	8 AWG (10 mm ²)	Not applicable
Environmental		
Operating temperature range	32° to +104° F (0° to +40° C)	
Operating humidity range	10 to 90% relative humidity (non-condensing)	
Operating altitude range	0 to 2,000 meters (6,600 ft) above sea level (without derating output power)	
Storage temperature range	-4° to +140° F (-20° to +60°C)	
Safety		
Agency approvals	Designed to meet UL 60950 (UL/cUL listing pending)	
Warranty		
Two-year limited warranty on parts and labor		

*Note: For continuous product improvement, specifications are subject to change without notice.

Technical Specifications*

[208 V, 2496 VA]

Model	VRP-2500-500A	VRP-2500-511A	VRP-2500-522A	VRP-2500-533A
Electrical				
Capacity / (VA)	2496			
Design topology	High-performance PWM voltage regulator operating at 20 kHz			
Voltage correction time	8 - 10 ms (½ line cycle)			
AC Input				
Input voltage range	208 V ±20% (166 – 250 V)			
Frequency	50/60 Hz ± 5 %			
Input circuit breaker rating	15 A			
AC Input connector	Hard-wired	NEMA 6-15P	NEMA L6-15P	IEC 60320 C20
Surge protection	Three-stage surge protector protects both the VRP and connected equipment from surges & spikes			
AC Output				
Output voltage	208 V ± 3%			
Power efficiency	97% typical (for load of 50 to 100%)			
Maximum rated output current	12.0 A			
System status indicator	Green LED ON-Normal operation - Amber LED ON-Bypass operation Red LED ON-Fault			
Output connector	Hard-wired	NEMA 6-15R	NEMA L6-15R	IEC 60320 C19
Physical				
Dimension (W x H x D)	12" (305 mm) x 6.2" (158 mm) x 15" (381 mm)			
Weight	40 lbs (18.1 kg)			
Wall / floor mounting kit	MK-4000C			
Max wire size (hard-wired)	8 AWG (10 mm ²)	Not applicable		
Environmental				
Operating temperature range	32° to +104° F (0° to +40° C)			
Operating humidity range	10 to 90% relative humidity (non-condensing)			
Operating altitude range	0 to 2,000 meters (6,600 ft) above sea level (without derating output power)			
Storage temperature range	-4° to +140° F (-20° to +60°C)			
Safety				
Agency approvals	Designed to meet UL 60950 (UL/cUL listing pending)			
Warranty				
Two-year limited warranty on parts and labor				

*Note: For continuous product improvement, specifications are subject to change without notice.

Technical Specifications*

[208 V, 3328 VA]

Model	VRP-3300-500A	VRP-3300-511A	VRP-3300-522A
Electrical			
Capacity / (VA)	3328		
Design topology	High-performance PWM voltage regulator operating at 20 kHz		
Voltage correction time	8 - 10 ms (½ line cycle)		
AC Input			
Input voltage range	208 V ±20% (166 – 250 V)		
Frequency	50/60 Hz ± 5 %		
Input circuit breaker rating	20 A		
AC Input connector	Hard-wired	NEMA 6-20P	NEMA L6-20P
Surge protection	Three-stage surge protector protects both the VRP and connected equipment from surges & spikes		
AC Output			
Output voltage	208 V ± 3%		
Power efficiency	97% typical (for load of 50 to 100%)		
Maximum rated output current	16.0 A		
System status indicator	Green LED ON-Normal operation - Amber LED ON-Bypass operation Red LED ON-Fault		
Output connector	Hard-wired	NEMA 6-20R	NEMA L6-20R
Physical			
Dimension (W x H x D)	12" (305 mm) x 6.2" (158 mm) x 15" (381 mm)		
Weight	47 lbs (21.3 kg)		
Wall / floor mounting kit	MK-4000C		
Max wire size (hard-wired)	Not applicable		
Environmental			
Operating temperature range	32° to +104° F (0° to +40° C)		
Operating humidity range	10 to 90% relative humidity (non-condensing)		
Operating altitude range	0 to 2,000 meters (6,600 ft) above sea level (without derating output power)		
Storage temperature range	-4° to +140° F (-20° to +60°C)		
Safety			
Agency approvals	Designed to meet UL 60950 (UL/cUL listing pending)		
Warranty			
Two-year limited warranty on parts and labor			

*Note: For continuous product improvement, specifications are subject to change without notice.

Technical Specifications*

[208 V, 4992 VA]

Model	VRP-5000-500A	VRP-5000-511A	VRP-5000-522A
Electrical			
Capacity / (VA)	4992		
Design topology	High-performance PWM voltage regulator operating at 20 kHz		
Voltage correction time	8 - 10 ms (½ line cycle)		
AC Input			
Input voltage range	208 V ±20% (166 – 250 V)		
Frequency	50/60 Hz ± 5 %		
Input circuit breaker rating	30 A		
AC Input connector	Hard-wired	NEMA 6-30P	NEMA L6-30P
Surge protection	Three-stage surge protector protects both the VRP and connected equipment from surges & spikes		
AC Output			
Output voltage	208 V ± 3%		
Power efficiency	97% typical (for load of 50 to 100%)		
Maximum rated output current	24.0 A		
System status indicator	Green LED ON-Normal operation - Amber LED ON-Bypass operation Red LED ON-Fault		
Output connector	Hard-wired	NEMA 6-30R	NEMA L6-30R
Physical			
Dimension (W x H x D)	12" (305 mm) x 6.2" (158 mm) x 15" (381 mm)		
Weight	49 lbs (22.2 kg)		
Wall / floor mounting kit	MK-4000C		
Max wire size (hard-wired)	8 AWG (10 mm ²)	Not applicable	
Environmental			
Operating temperature range	32° to +104° F (0° to +40° C)		
Operating humidity range	10 to 90% relative humidity (non-condensing)		
Operating altitude range	0 to 2,000 meters (6,600 ft) above sea level (without derating output power)		
Storage temperature range	-4° to +140° F (-20° to +60°C)		
Safety			
Agency approvals	Designed to meet UL 60950 (UL/cUL listing pending)		
Warranty			
Two-year limited warranty on parts and labor			

*Note: For continuous product improvement, specifications are subject to change without notice.

Technical Specifications*

[208 V, 6656/8320 VA]

Model	VRP-6700-500A	VRP-8300-500A	VRP-8300-511A
Electrical			
Capacity / (VA)	6656	8320	
Design topology	High-performance PWM voltage regulator operating at 20 kHz		
Voltage correction time	8 - 10 ms (½ line cycle)		
AC Input			
Input voltage range	208 V ±20% (166 – 250 V)		
Frequency	50/60 Hz ± 5 %		
Input circuit breaker rating	40 A	50 A	
AC Input connector	Hard-wired		NEMA 6-50P
Surge protection	Three-stage surge protector protects both the VRP and connected equipment from surges & spikes		
AC Output			
Output voltage	208 V ± 3%		
Power efficiency	97% typical (for load of 50 to 100%)		
Maximum rated output current	32.0 A	40.0 A	
System status indicator	Green LED ON-Normal operation - Amber LED ON-Bypass operation Red LED ON-Fault		
Output connector	Hard-wired		NEMA 6-50R
Physical			
Dimension (W x H x D)	14.5" (368 mm) x 8.9" (226 mm) x 19.8" (502 mm)		
Weight	86 lbs (39 kg)	104 lbs (47.2 kg)	
Wall / floor mounting kit	MK-8000C		
Max wire size (hard-wired)	8 AWG (10 mm ²)	8 AWG (10 mm ²)	Not applicable
Environmental			
Operating temperature range	32° to +104° F (0° to +40° C)		
Operating humidity range	10 to 90% relative humidity (non-condensing)		
Operating altitude range	0 to 2,000 meters (6,600 ft) above sea level (without derating output power)		
Storage temperature range	-4° to +140° F (-20° to +60°C)		
Safety			
Agency approvals	Designed to meet UL 60950 (UL/cUL listing pending)		
Warranty			
Two-year limited warranty on parts and labor			

*Note: For continuous product improvement, specifications are subject to change without notice.

Technical Specifications*

[208 V, 13312/14976/16640 VA]

Model	VRP-13300-500A	VRP-15000-500A	VRP-16700-500A
Electrical			
Capacity / (VA)	13312	14976	16640
Design topology	High-performance PWM voltage regulator operating at 20 kHz		
Voltage correction time	8 - 10 ms (½ line cycle)		
AC Input			
Input voltage range	208 V ±20% (166 – 250 V)		
Frequency	50/60 Hz ± 5 %		
Input circuit breaker rating	80 A	90 A	100 A
AC Input connector	Hard-wired		
Surge protection	Three-stage surge protector protects both the VRP and connected equipment from surges & spikes		
AC Output			
Output voltage	208 V ± 3%		
Power efficiency	97% typical (for load of 50 to 100%)		
Maximum rated output current	64.0 A	72.0 A	80.0 A
System status indicator	Green LED ON-Normal operation - Amber LED ON-Bypass operation Red LED ON-Fault		
Output connector	Hard-wired		
Physical			
Dimension (W x H x D)	14.5" (368 mm) x 8.9" (226 mm) x 19.8" (502 mm)		
Weight	116 lbs (52.69 kg)	118 lbs (53.5 kg)	127 lbs (57.6 kg)
Wall / floor mounting kit	MK-8000C		
Max wire size (hard-wired)	2 AWG (35 mm ²)		
Environmental			
Operating temperature range	32° to +104° F (0° to +40° C)		
Operating humidity range	10 to 90% relative humidity (non-condensing)		
Operating altitude range	0 to 2,000 meters (6,600 ft) above sea level (without derating output power)		
Storage temperature range	-4° to +140° F (-20° to +60°C)		
Safety			
Agency approvals	Designed to meet UL 60950 (UL/cUL listing pending)		
Warranty			
Two-year limited warranty on parts and labor			

*Note: For continuous product improvement, specifications are subject to change without notice.

Technical Specifications*

[208 V, 31283 VA]

Model	VRP-31300-500A
Electrical	
Capacity / (VA)	31283
Design topology	High-performance PWM voltage regulator operating at 20 kHz
Voltage correction time	8 - 10 ms (½ line cycle)
AC Input	
Input voltage range	208 V ±20% (166 – 250 V)
Frequency	50/60 Hz ± 5 %
Input circuit breaker rating	None
AC Input connector	Hard-wired
Surge protection	Three-stage surge protector protects both the VRP and connected equipment from surges & spikes
AC Output	
Output voltage	208 V ± 3%
Power efficiency	97% typical (for load of 50 to 100%)
Maximum rated output current	150.4 A
System status indicator	Green LED ON-Normal operation - Amber LED ON-Bypass operation Red LED ON-Fault
Output connector	Hard-wired
Physical	
Dimension (W x H x D)	24.0" (610 mm) x 24.6" (625 mm) x 24.0" (610 mm)
Weight	355 lbs (161.0 kg)
Wall / floor mounting kit	Not applicable
Max wire size (hard-wired)	4/0 AWG (120 mm ²)
Environmental	
Operating temperature range	32° to +104° F (0° to +40° C)
Operating humidity range	10 to 90% relative humidity (non-condensing)
Operating altitude range	0 to 2,000 meters (6,600 ft) above sea level (without derating output power)
Storage temperature range	-4° to +140° F (-20° to +60°C)
Safety	
Agency approvals	Designed to meet UL 60950 (UL/cUL listing pending)
Warranty	
Two-year limited warranty on parts and labor	

*Note: For continuous product improvement, specifications are subject to change without notice.

Technical Specifications*

[220 V, 1760 VA]

Model	VRP-1800-600A	VRP-1800-633A
Electrical		
Capacity / (VA)	1760	
Design topology	High-performance PWM voltage regulator operating at 20 kHz	
Voltage correction time	8 - 10 ms (½ line cycle)	
AC Input		
Input voltage range	220 V ± 20% (176 – 264 V)	
Frequency	50/60 Hz ± 5 %	
Input circuit breaker rating	10 A	
AC input connector	Hard-wired	IEC 60320 C14
Surge protection	Three-stage surge protector protects both the VRP and connected equipment from surges & spikes	
AC Output		
Output voltage	220 V ± 3%	
Power efficiency	97% typical (for load of 50 to 100%)	
Maximum rated output current	8.0 A	
System status indicator	Green LED ON-Normal operation - Amber LED ON-Bypass operation Red LED ON-Fault	
Output connector	Hard-wired	IEC 60320 C13
Physical		
Dimension (W x H x D)	12" (305 mm) x 6.2" (158 mm) x 15" (381 mm)	
Weight	32 lbs (14.5 kg)	
Wall / floor mounting kit	MK-4000C	
Max wire size (hard-wired)	8 AWG (10 mm ²)	Not applicable
Environmental		
Operating temperature range	32° to +104° F (0° to +40° C)	
Operating humidity range	10 to 90% relative humidity (non-condensing)	
Operating altitude range	0 to 2,000 meters (6,600 ft) above sea level (without derating output power)	
Storage temperature range	-4° to +140° F (-20° to +60°C)	
Safety		
Agency approvals	Designed to meet UL 60950 (UL/cUL listing pending)	
Warranty		
Two-year limited warranty on parts and labor		

*Note: For continuous product improvement, specifications are subject to change without notice.

Technical Specifications*

[220 V, 2640 VA]

Model	VRP-2600-600A	VRP-2600-611A	VRP-2600-622A	VRP-2600-633A
-------	---------------	---------------	---------------	---------------

Electrical

Capacity / (VA)	2640
Design topology	High-performance PWM voltage regulator operating at 20 kHz
Voltage correction time	8 - 10 ms (½ line cycle)

AC Input

Input voltage range	220 V ± 20% (176 – 264 V)			
Frequency	50/60 Hz ± 5 %			
Input circuit breaker rating	15 A			
AC input connector	Hard-wired	NEMA 6-15P	NEMA L6-15P	IEC 60320 C20
Surge protection	Three-stage surge protector protects both the VRP and connected equipment from surges & spikes			

AC Output

Output voltage	220 V ± 3%			
Power efficiency	97% typical (for load of 50 to 100%)			
Maximum rated output current	12.0 A			
System status indicator	Green LED ON-Normal operation - Amber LED ON-Bypass operation Red LED ON-Fault			
Output connector	Hard-wired	NEMA 6-15R	NEMA L6-15R	IEC 60320 C19

Physical

Dimension (W x H x D)	12" (305 mm) x 6.2" (158 mm) x 15" (381 mm)			
Weight	40 lbs (18.1 kg)			
Wall / floor mounting kit	MK-4000C			
Max wire size (hard-wired)	8 AWG (10 mm ²)	Not applicable		

Environmental

Operating temperature range	32° to +104° F (0° to +40° C)			
Operating humidity range	10 to 90% relative humidity (non-condensing)			
Operating altitude range	0 to 2,000 meters (6,600 ft) above sea level (without derating output power)			
Storage temperature range	-4° to +140° F (-20° to +60°C)			

Safety

Agency approvals	Designed to meet UL 60950 (UL/cUL listing pending)			
------------------	--	--	--	--

Warranty

Two-year limited warranty on parts and labor

*Note: For continuous product improvement, specifications are subject to change without notice.

Technical Specifications*

[220 V, 3520 VA]

Model	VRP-3500-600A	VRP-3500-611A	VRP-3500-622A
Electrical			
Capacity / (VA)	3520		
Design topology	High-performance PWM voltage regulator operating at 20 kHz		
Voltage correction time	8 - 10 ms (½ line cycle)		
AC Input			
Input voltage range	220 V ± 20% (176 – 264 V)		
Frequency	50/60 Hz ± 5 %		
Input circuit breaker rating	20 A		
AC input connector	Hard-wired	NEMA 6-20P	NEMA L6-20P
Surge protection	Three-stage surge protector protects both the VRP and connected equipment from surges & spikes		
AC Output			
Output voltage	220 V ± 3%		
Power efficiency	97% typical (for load of 50 to 100%)		
Maximum rated output current	16.0 A		
System status indicator	Green LED ON-Normal operation - Amber LED ON-Bypass operation Red LED ON-Fault		
Output connector	Hard-wired	NEMA 6-20R	NEMA L6-20R
Physical			
Dimension (W x H x D)	12" (305 mm) x 6.2" (158 mm) x 15" (381 mm)		
Weight	47 lbs (21.3 kg)		
Wall / floor mounting kit	MK-4000C		
Max wire size (hard-wired)	Not applicable		
Environmental			
Operating temperature range	32° to +104° F (0° to +40° C)		
Operating humidity range	10 to 90% relative humidity (non-condensing)		
Operating altitude range	0 to 2,000 meters (6,600 ft) above sea level (without derating output power)		
Storage temperature range	-4° to +140° F (-20° to +60°C)		
Safety			
Agency approvals	Designed to meet UL 60950 (UL/cUL listing pending)		
Warranty			
Two-year limited warranty on parts and labor			

*Note: For continuous product improvement, specifications are subject to change without notice.

Technical Specifications*

[220 V, 5280 VA]

Model	VRP-5300-600A	VRP-5300-611A	VRP-5300-622A
Electrical			
Capacity / (VA)	5280		
Design topology	High-performance PWM voltage regulator operating at 20 kHz		
Voltage correction time	8 - 10 ms (½ line cycle)		
AC Input			
Input voltage range	220 V ± 20% (176 – 264 V)		
Frequency	50/60 Hz ± 5 %		
Input circuit breaker rating	30 A		
AC input connector	Hard-wired	NEMA 6-30P	NEMA L6-30P
Surge protection	Three-stage surge protector protects both the VRP and connected equipment from surges & spikes		
AC Output			
Output voltage	220 V ± 3%		
Power efficiency	97% typical (for load of 50 to 100%)		
Maximum rated output current	24.0 A		
System status indicator	Green LED ON-Normal operation - Amber LED ON-Bypass operation Red LED ON-Fault		
Output connector	Hard-wired	NEMA 6-30R	NEMA L6-30R
Physical			
Dimension (W x H x D)	12" (305 mm) x 6.2" (158 mm) x 15" (381 mm)		
Weight	49 lbs (22.2 kg)		
Wall / floor mounting kit	MK-4000C		
Max wire size (hard-wired)	8 AWG (10 mm ²)	Not applicable	
Environmental			
Operating temperature range	32° to +104° F (0° to +40° C)		
Operating humidity range	10 to 90% relative humidity (non-condensing)		
Operating altitude range	0 to 2,000 meters (6,600 ft) above sea level (without derating output power)		
Storage temperature range	-4° to +140° F (-20° to +60°C)		
Safety			
Agency approvals	Designed to meet UL 60950 (UL/cUL listing pending)		
Warranty			
Two-year limited warranty on parts and labor			

*Note: For continuous product improvement, specifications are subject to change without notice.

Technical Specifications*

[220 V, 7040/8800 VA]

Model	VRP-7000-600A	VRP-8800-600A	VRP-8800-611A
Electrical			
Capacity / (VA)	7040	8800	
Design topology	High-performance PWM voltage regulator operating at 20 kHz		
Voltage correction time	8 - 10 ms (½ line cycle)		
AC Input			
Input voltage range	220 V ± 20% (176 – 264 V)		
Frequency	50/60 Hz ± 5 %		
Input circuit breaker rating	40 A	50 A	
AC input connector	Hard-wired		NEMA 6-50P
Surge protection	Three-stage surge protector protects both the VRP and connected equipment from surges & spikes		
AC Output			
Output voltage	230 V ± 3%		
Power efficiency	97% typical (for load of 50 to 100%)		
Maximum rated output current	32.0 A	40.0 A	
System status indicator	Green LED ON-Normal operation - Amber LED ON-Bypass operation Red LED ON-Fault		
Output connector	Hard-wired		NEMA 6-50R
Physical			
Dimension (W x H x D)	14.5" (368 mm) x 8.9" (226 mm) x 19.8" (502 mm)		
Weight	86 lbs (39 kg)	104.0 lbs (47.2 kg)	
Wall / floor mounting kit	MK-8000C		
Max wire size (hard-wired)	8 AWG (10 mm ²)		Not applicable
Environmental			
Operating temperature range	32° to +104° F (0° to +40° C)		
Operating humidity range	10 to 90% relative humidity (non-condensing)		
Operating altitude range	0 to 2,000 meters (6,600 ft) above sea level (without derating output power)		
Storage temperature range	-4° to +140° F (-20° to +60°C)		
Safety			
Agency approvals	Designed to meet UL 60950 (UL/cUL listing pending)		
Warranty			
Two-year limited warranty on parts and labor			

*Note: For continuous product improvement, specifications are subject to change without notice.

Technical Specifications* [220 V, 12320/14080/15840 VA]

Model	VRP-12300-600A	VRP-14100-600A	VRP-15800-600A
Electrical			
Capacity / (VA)	12320	14080	15840
Design topology	High-performance PWM voltage regulator operating at 20 kHz		
Voltage correction time	8 - 10 ms (½ line cycle)		
AC Input			
Input voltage range	220 V ± 20% (176 – 264 V)		
Frequency	50/60 Hz ± 5 %		
Input Circuit breaker rating	70 A	80 A	90 A
AC Input connector	Hard-wired		
Surge protection	Three-stage surge protector protects both the VRP and connected equipment from surges & spikes		
AC Output			
Output voltage	220 V ± 3%		
Power efficiency	97% typical (for load of 50 to 100%)		
Maximum rated output current	56.0 A	64.0 A	72.0 A
System status indicator	Green LED ON-Normal operation - Amber LED ON-Bypass operation Red LED ON-Fault		
Output connector	Hard-wired		
Physical			
Dimension (W x H x D)	14.5" (368 mm) x 8.9" (226 mm) x 19.8" (502 mm)		
Weight	116.0 lbs (52.6 kg)	116.0 lbs (52.6 kg)	118.0 lbs (53.5 kg)
Wall / floor mounting kit	MK-8000C		
Max wire size (hard-wired)	6 AWG (16 mm ²)	2 AWG (35 mm ²)	2 AWG (35 mm ²)
Environmental			
Operating temperature range	32° to +104° F (0° to +40° C)		
Operating humidity range	10 to 90% relative humidity (non-condensing)		
Operating altitude range	0 to 2,000 meters (6,600 ft) above sea level (without derating output power)		
Storage temperature range	-4° to +140° F (-20° to +60°C)		
Safety			
Agency approvals	Designed to meet UL 60950 (UL/cUL listing pending)		
Warranty			
Two-year limited warranty on parts and labor			

*Note: For continuous product improvement, specifications are subject to change without notice.

Technical Specifications*

[220 V, 17600/33088 VA]

Model	VRP-17600-600A	VRP-33100-600A
Electrical		
Capacity / (VA)	17600	33088
Design topology	High-performance PWM voltage regulator operating at 20 kHz	
Voltage correction time	8 - 10 ms (½ line cycle)	
AC Input		
Input voltage range	220 V ± 20% (176 – 264 V)	
Frequency	50/60 Hz ± 5 %	
Input Circuit breaker rating	100 A	None
AC Input connector	Hard-wired	
Surge protection	Three-stage surge protector protects both the VRP and connected equipment from surges & spikes	
AC Output		
Output voltage	220 V ± 3%	
Power efficiency	97% typical (for load of 50 to 100%)	
Maximum rated output current	80.0 A	150.4 A
System status indicator	Green LED ON-Normal operation - Amber LED ON-Bypass operation Red LED ON-Fault	
Output connector	Hard-wired	
Physical		
Dimension (W x H x D)	14.5" (368 mm) x 8.9" (226 mm) x 19.8" (502 mm)	24.0" (610 mm) x 24.6" (625 mm) x 24.0" (610 mm)
Weight	127.0 lbs (57.6 kg)	355.0 lbs (161.0 kg)
Wall / floor mounting kit	MK-8000C	Not applicable
Max wire size (hard-wired)	2 AWG (35 mm ²)	4/0 AWG (120 mm ²)
Environmental		
Operating temperature range	32° to +104° F (0° to +40° C)	
Operating humidity range	10 to 90% relative humidity (non-condensing)	
Operating altitude range	0 to 2,000 meters (6,600 ft) above sea level (without derating output power)	
Storage temperature range	-4° to +140° F (-20° to +60°C)	
Safety		
Agency approvals	Designed to meet UL 60950 (UL/cUL listing pending)	
Warranty		
Two-year limited warranty on parts and labor		

*Note: For continuous product improvement, specifications are subject to change without notice.

Technical Specifications*

[230 V, 1840 VA]

Model	VRP-1800-700A	VRP-1800-733A	VRP-1800-755A	VRP-1800-766A
-------	---------------	---------------	---------------	---------------

Electrical

Capacity / (VA)	1840
Design topology	High-performance PWM voltage regulator operating at 20 kHz
Voltage correction time	8 - 10 ms (½ line cycle)

AC Input

Input voltage range	230 V ± 20% (184 – 276 V)			
Frequency	50/60 Hz ± 5 %			
Input circuit breaker rating	10 A			
AC input connector	Hard-wired	IEC 60320 C14	BS1363 Plug	AS/NZS 3112 10 A Plug
Surge protection	Three-stage surge protector protects both the VRP and connected equipment from surges & spikes			

AC Output

Output voltage	230 V ± 3%			
Power efficiency	97% typical (for load of 50 to 100%)			
Maximum rated output current	8.0 A			
System status indicator	Green LED ON-Normal operation - Amber LED ON-Bypass operation Red LED ON-Fault			
Output connector	Hard-wired	IEC 60320 C13	BS1363 Socket	AS/NZS 3112 10 A Socket

Physical

Dimension (W x H x D)	12" (305 mm) x 6.2" (158 mm) x 15" (381 mm)			
Weight	32 lbs (14.5 kg)			
Wall / floor mounting kit	MK-4000C			
Max wire size (hard-wired)	8 AWG (10 mm ²)	Not applicable		

Environmental

Operating temperature range	32° to +104° F (0° to +40° C)			
Operating humidity range	10 to 90% relative humidity (non-condensing)			
Operating altitude range	0 to 2,000 meters (6,600 ft) above sea level (without derating output power)			
Storage temperature range	-4° to +140° F (-20° to +60°C)			

Safety

Agency approvals	Designed to meet UL 60950 (UL/cUL listing pending)			
------------------	--	--	--	--

Warranty

Two-year limited warranty on parts and labor

*Note: For continuous product improvement, specifications are subject to change without notice.

Technical Specifications*

[230 V, 2760 VA]

Model	VRP-2800-700A	VRP-2800-711A	VRP-2800-722A
Electrical			
Capacity / (VA)	2760		
Design topology	High-performance PWM voltage regulator operating at 20 kHz		
Voltage correction time	8 - 10 ms (½ line cycle)		
AC Input			
Input voltage range	230 V ± 20% (184 – 276 V)		
Frequency	50/60 Hz ± 5 %		
Input circuit breaker rating	15 A		
AC input connector	Hard-wired	NEMA 6-15P	NEMA L6-15P
Surge protection	Three-stage surge protector protects both the VRP and connected equipment from surges & spikes		
AC Output			
Output voltage	230 V ± 3%		
Power efficiency	97% typical (for load of 50 to 100%)		
Maximum rated output current	12.0 A		
System status indicator	Green LED ON-Normal operation - Amber LED ON-Bypass operation Red LED ON-Fault		
Output connector	Hard-wired	NEMA 6-15R	NEMA L6-15R
Physical			
Dimension (W x H x D)	12" (305 mm) x 6.2" (158 mm) x 15" (381 mm)		
Weight	40 lbs (18.1 kg)		
Wall / floor mounting kit	MK-4000C		
Max wire size (hard-wired)	8 AWG (10 mm ²)	Not applicable	
Environmental			
Operating temperature range	32° to +104° F (0° to +40° C)		
Operating humidity range	10 to 90% relative humidity (non-condensing)		
Operating altitude range	0 to 2,000 meters (6,600 ft) above sea level (without derating output power)		
Storage temperature range	-4° to +140° F (-20° to +60°C)		
Safety			
Agency approvals	Designed to meet UL 60950 (UL/cUL listing pending)		
Warranty			
Two-year limited warranty on parts and labor			

*Note: For continuous product improvement, specifications are subject to change without notice.

Technical Specifications*

[230 V, 3680 VA]

Model	VRP-3700-700A	VRP-3700-711A	VRP-3700-722A	VRP-3700-766A
-------	---------------	---------------	---------------	---------------

Electrical

Capacity / (VA)	3680
Design topology	High-performance PWM voltage regulator operating at 20 kHz
Voltage correction time	8 - 10 ms (½ line cycle)

AC Input

Input voltage range	230 V ± 20% (184 – 276 V)			
Frequency	50/60 Hz ± 5 %			
Input circuit breaker rating	20 A			
AC input connector	Hard-wired	NEMA 6-20P	NEMA L6-20P	AS/NZS 3112 20 A Plug
Surge protection	Three-stage surge protector protects both the VRP and connected equipment from surges & spikes			

AC Output

Output voltage	230 V ± 3%			
Power efficiency	97% typical (for load of 50 to 100%)			
Maximum rated output current	16.0 A			
System status indicator	Green LED ON-Normal operation - Amber LED ON-Bypass operation Red LED ON-Fault			
Output connector	Hard-wired	NEMA 6-20R	NEMA L6-20R	AS/NZS 3112 20 A Socket

Physical

Dimension (W x H x D)	12" (305 mm) x 6.2" (158 mm) x 15" (381 mm)
Weight	47 lbs (21.3 kg)
Wall / floor mounting kit	MK-4000C
Max wire size (hard-wired)	Not applicable

Environmental

Operating temperature range	32° to +104° F (0° to +40° C)
Operating humidity range	10 to 90% relative humidity (non-condensing)
Operating altitude range	0 to 2,000 meters (6,600 ft) above sea level (without derating output power)
Storage temperature range	-4° to +140° F (-20° to +60°C)

Safety

Agency approvals	Designed to meet UL 60950 (UL/cUL listing pending)
------------------	--

Warranty

Two-year limited warranty on parts and labor

*Note: For continuous product improvement, specifications are subject to change without notice.

Technical Specifications*

[230 V, 5520 VA]

Model	VRP-5500-700A	VRP-5500-711A	VRP-5500-722A	VRP-5500-766A
-------	---------------	---------------	---------------	---------------

Electrical

Capacity / (VA)	5520
Design topology	High-performance PWM voltage regulator operating at 20 kHz
Voltage correction time	8 - 10 ms (½ line cycle)

AC Input

Input voltage range	230 V ± 20% (184 – 276 V)			
Frequency	50/60 Hz ± 5 %			
Input circuit breaker rating	30 A			
AC input connector	Hard-wired	NEMA 6-30P	NEMA L6-30P	AS/NZS 3112 32 A Plug
Surge protection	Three-stage surge protector protects both the VRP and connected equipment from surges & spikes			

AC Output

Output voltage	230 V ± 3%			
Power efficiency	97% typical (for load of 50 to 100%)			
Maximum rated output current	24.0 A			
System status indicator	Green LED ON-Normal operation - Amber LED ON-Bypass operation Red LED ON-Fault			
Output connector	Hard-wired	NEMA 6-30R	NEMA L6-30R	AS/NZS 3112 32 A Socket

Physical

Dimension (W x H x D)	12" (305 mm) x 6.2" (158 mm) x 15" (381 mm)			
Weight	49.0 lbs (22.2 kg)			
Wall / floor mounting kit	MK-4000C			
Max wire size (hard-wired)	8 AWG (10 mm ²)	Not applicable		

Environmental

Operating temperature range	32° to +104° F (0° to +40° C)			
Operating humidity range	10 to 90% relative humidity (non-condensing)			
Operating altitude range	0 to 2,000 meters (6,600 ft) above sea level (without derating output power)			
Storage temperature range	-4° to +140° F (-20° to +60°C)			

Safety

Agency approvals	Designed to meet UL 60950 (UL/cUL listing pending)			
------------------	--	--	--	--

Warranty

Two-year limited warranty on parts and labor

*Note: For continuous product improvement, specifications are subject to change without notice.

Technical Specifications*

[230 V, 7360/9200 VA]

Model	VRP-7400-700A	VRP-9200-700A	VRP-9200-711A
Electrical			
Capacity / (VA)	7360	9200	
Design topology	High-performance PWM voltage regulator operating at 20 kHz		
Voltage correction time	8 - 10 ms (½ line cycle)		
AC Input			
Input voltage range	230 V ± 20% (184 – 276 V)		
Frequency	50/60 Hz ± 5 %		
Input circuit breaker rating	40 A	50 A	
AC input connector	Hard-wired		NEMA 6-50P
Surge protection	Three-stage surge protector protects both the VRP and connected equipment from surges & spikes		
AC Output			
Output voltage	230 V ± 3%		
Power efficiency	97% typical (for load of 50 to 100%)		
Maximum rated output current	32.0 A	40.0 A	
System status indicator	Green LED ON-Normal operation - Amber LED ON-Bypass operation Red LED ON-Fault		
Output connector	Hard-wired		NEMA 6-50R
Physical			
Dimension (W x H x D)	14.5" (368 mm) x 8.9" (226 mm) x 19.8" (502 mm)		
Weight	86 lbs (39 kg)	104.0 lbs (47.2 kg)	
Wall / floor mounting kit	MK-8000C		
Max wire size (hard-wired)	8 AWG (10 mm ²)	8 AWG (10 mm ²)	Not applicable
Environmental			
Operating temperature range	32° to +104° F (0° to +40° C)		
Operating humidity range	10 to 90% relative humidity (non-condensing)		
Operating altitude range	0 to 2,000 meters (6,600 ft) above sea level (without derating output power)		
Storage temperature range	-4° to +140° F (-20° to +60°C)		
Safety			
Agency approvals	Designed to meet UL 60950 (UL/cUL listing pending)		
Warranty			
Two-year limited warranty on parts and labor			

*Note: For continuous product improvement, specifications are subject to change without notice.

Technical Specifications* [230 V, 14720/16560/18400 VA]

Model	VRP-14700-700A	VRP-16600-700A	VRP-18400-700A
Electrical			
Capacity / (VA)	14720	16560	18400
Design topology	High-performance PWM voltage regulator operating at 20 kHz		
Voltage correction time	8 - 10 ms (½ line cycle)		
AC Input			
Input voltage range	230 V ± 20% (184 – 276 V)		
Frequency	50/60 Hz ± 5 %		
Input Circuit breaker rating	80 A	90 A	100 A
AC Input connector	Hard-wired		
Surge protection	Three-stage surge protector protects both the VRP and connected equipment from surges & spikes		
AC Output			
Output voltage	230 V ± 3%		
Power efficiency	97% typical (for load of 50 to 100%)		
Maximum rated output current	64.0 A	72.0 A	80.0 A
System status indicator	Green LED ON-Normal operation - Amber LED ON-Bypass operation Red LED ON-Fault		
Output connector	Hard-wired		
Physical			
Dimension (W x H x D)	14.5" (368 mm) x 8.9" (226 mm) x 19.8" (502 mm)		
Weight	116.0 lbs (52.6 kg)	118.0 lbs (53.5 kg)	127 lbs (57.6 kg)
Wall / floor mounting kit	MK-8000C		
Max wire size (hard-wired)	2 AWG (35 mm ²)		
Environmental			
Operating temperature range	32° to +104° F (0° to +40° C)		
Operating humidity range	10 to 90% relative humidity (non-condensing)		
Operating altitude range	0 to 2,000 meters (6,600 ft) above sea level (without derating output power)		
Storage temperature range	-4° to +140° F (-20° to +60°C)		
Safety			
Agency approvals	Designed to meet UL 60950 (UL/cUL listing pending)		
Warranty			
Two-year limited warranty on parts and labor			

*Note: For continuous product improvement, specifications are subject to change without notice.

Technical Specifications*

[230 V, 34592 VA]

Model	VRP-34600-700A
Electrical	
Capacity / (VA)	34592
Design topology	High-performance PWM voltage regulator operating at 20 kHz
Voltage correction time	8 - 10 ms (½ line cycle)
AC Input	
Input voltage range	230 V ± 20% (184 – 276 V)
Frequency	50/60 Hz ± 5 %
Input Circuit breaker rating	None
AC Input connector	Hard-wired
Surge protection	Three-stage surge protector protects both the VRP and connected equipment from surges & spikes
AC Output	
Output voltage	230 V ± 3%
Power efficiency	97% typical (for load of 50 to 100%)
Maximum rated output current	150.4 A
System status indicator	Green LED ON-Normal operation - Amber LED ON-Bypass operation Red LED ON-Fault
Output connector	Hard-wired
Physical	
Dimension (W x H x D)	24.0" (610 mm) x 24.6" (625 mm) x 24.0" (610 mm)
Weight	355.0 lbs (161.0 kg)
Wall / floor mounting kit	Not applicable
Max wire size (hard-wired)	4/0 AWG (120 mm ²)
Environmental	
Operating temperature range	32° to +104° F (0° to +40° C)
Operating humidity range	10 to 90% relative humidity (non-condensing)
Operating altitude range	0 to 2,000 meters (6,600 ft) above sea level (without derating output power)
Storage temperature range	-4° to +140° F (-20° to +60°C)
Safety	
Agency approvals	Designed to meet UL 60950 (UL/cUL listing pending)
Warranty	
Two-year limited warranty on parts and labor	

*Note: For continuous product improvement, specifications are subject to change without notice.

Technical Specifications*

[240 V, 1920 VA]

Model	VRP-1900-800A	VRP-1900-833A
Electrical		
Capacity / (VA)	1920	
Design topology	High-performance PWM voltage regulator operating at 20 kHz	
Voltage correction time	8 ms (½ line cycle)	
AC Input		
Input voltage range	240 V ±20% (192 – 288 V)	
Frequency	50/60 Hz ± 5 %	
Input circuit breaker rating	10 A	
AC input connector	Hard-wired	IEC 60320 C14
Surge protection	Three-stage surge protector protects both the VRP and connected equipment from surges & spikes	
AC Output		
Output voltage	240 V ± 3%	
Power efficiency	97% typical (for load of 50 to 100%)	
Maximum rated output current	8.0 A	
System status indicator	Green LED ON-Normal operation - Amber LED ON-Bypass operation Red LED ON-Fault	
Output connector	Hard-wired	IEC 60320 C13
Physical		
Dimension (W x H x D)	12" (305 mm) x 6.2" (158 mm) x 15" (381 mm)	
Weight	32 lbs (14.5 kg)	
Wall / floor mounting kit	MK-4000C	
Max wire size (hard-wired)	8 AWG (10 mm ²)	Not applicable
Environmental		
Operating temperature range	32° to +104° F (0° to +40° C)	
Operating humidity range	10 to 90% relative humidity (non-condensing)	
Operating altitude range	0 to 2,000 meters (6,600 ft) above sea level (without derating output power)	
Storage temperature range	-4° to +140° F (-20° to +60°C)	
Safety		
Agency approvals	Designed to meet UL 60950 (UL/cUL listing pending)	
Warranty		
Two-year limited warranty on parts and labor		

*Note: For continuous product improvement, specifications are subject to change without notice.

Technical Specifications*

[240 V, 2880 VA]

Model	VRP-2900-800A	VRP-2900-811A	VRP-2900-822A	VRP-2900-833A
-------	---------------	---------------	---------------	---------------

Electrical

Capacity / (VA)	2880
Design topology	High-performance PWM voltage regulator operating at 20 kHz
Voltage correction time	8 ms (½ line cycle)

AC Input

Input voltage range	240 V ± 20% (192 – 288 V)			
Frequency	50/60 Hz ± 5 %			
Input circuit breaker rating	15 A			
AC input connector	Hard-wired	NEMA 6-15P	NEMA L6-15P	IEC 60320 C20
Surge protection	Three-stage surge protector protects both the VRP and connected equipment from surges & spikes			

AC Output

Output voltage	240 V ± 3%			
Power efficiency	97% typical (for load of 50 to 100%)			
Maximum rated output current	12.0 A			
System status indicator	Green LED ON-Normal operation - Amber LED ON-Bypass operation Red LED ON-Fault			
Output connector	Hard-wired	NEMA 6-15R	NEMA L6-15R	IEC 60320 C19

Physical

Dimension (W x H x D)	12" (305 mm) x 6.2" (158 mm) x 15" (381 mm)			
Weight	40 lbs (18.1 kg)			
Wall / floor mounting kit	MK-4000C			
Max wire size (hard-wired)	8 AWG (10 mm ²)	Not applicable		

Environmental

Operating temperature range	32° to +104° F (0° to +40° C)			
Operating humidity range	10 to 90% relative humidity (non-condensing)			
Operating altitude range	0 to 2,000 meters (6,600 ft) above sea level (without derating output power)			
Storage temperature range	-4° to +140° F (-20° to +60°C)			

Safety

Agency approvals	Designed to meet UL 60950 (UL/cUL listing pending)			
------------------	--	--	--	--

Warranty

Two-year limited warranty on parts and labor

*Note: For continuous product improvement, specifications are subject to change without notice.

Technical Specifications*

[240 V, 3840 VA]

Model	VRP-3800-800A	VRP-3800-811A	VRP-3800-822A
Electrical			
Capacity / (VA)	3840		
Design topology	High-performance PWM voltage regulator operating at 20 kHz		
Voltage correction time	8 ms (½ line cycle)		
AC Input			
Input voltage range	240V ± 20% (192 – 288 V)		
Frequency	50/60 Hz ± 5 %		
Input circuit breaker rating	20 A		
AC input connector	Hard-wired	NEMA 6-20P	NEMA L6-20P
Surge protection	Three-stage surge protector protects both the VRP and connected equipment from surges & spikes		
AC Output			
Output voltage	240 V ± 3%		
Power efficiency	97% typical (for load of 50 to 100%)		
Maximum rated output current	16.0 A		
System status indicator	Green LED ON-Normal operation - Amber LED ON-Bypass operation Red LED ON-Fault		
Output connector	Hard-wired	NEMA 6-20P	NEMA L6-20P
Physical			
Dimension (W x H x D)	12" (305 mm) x 6.2" (158 mm) x 15" (381 mm)		
Weight	47 lbs (21.3 kg)		
Wall / floor mounting kit	MK-4000C		
Max wire size (hard-wired)	Not applicable		
Environmental			
Operating temperature range	32° to +104° F (0° to +40° C)		
Operating humidity range	10 to 90% relative humidity (non-condensing)		
Operating altitude range	0 to 2,000 meters (6,600 ft) above sea level (without derating output power)		
Storage temperature range	-4° to +140° F (-20° to +60°C)		
Safety			
Agency approvals	Designed to meet UL 60950 (UL/cUL listing pending)		
Warranty			
Two-year limited warranty on parts and labor			

*Note: For continuous product improvement, specifications are subject to change without notice.

Technical Specifications*

[240 V, 5760 VA]

Model	VRP-5800-800A	VRP-5800-811A	VRP-5800-822A
Electrical			
Capacity / (VA)	5760		
Design topology	High-performance PWM voltage regulator operating at 20 kHz		
Voltage correction time	8 ms (½ line cycle)		
AC Input			
Input voltage range	240 V ± 20% (192 – 288 V)		
Frequency	50/60 Hz ± 5 %		
Input circuit breaker rating	30 A		
AC input connector	Hard-wired	NEMA 6-30P	NEMA L6-30P
Surge protection	Three-stage surge protector protects both the VRP and connected equipment from surges & spikes		
AC Output			
Output voltage	240 V ± 3%		
Power efficiency	97% typical (for load of 50 to 100%)		
Maximum rated output current	24.0 A		
System status indicator	Green LED ON-Normal operation - Amber LED ON-Bypass operation Red LED ON-Fault		
Output connector	Hard-wired	NEMA 6-30R	NEMA L6-30R
Physical			
Dimension (W x H x D)	12" (305 mm) x 6.2" (158 mm) x 15" (381 mm)		
Weight	49 lbs (22.2 kg)		
Wall / floor mounting kit	MK-4000C		
Max wire size (hard-wired)	8 AWG (10 mm ²)	Not applicable	
Environmental			
Operating temperature range	32° to +104° F (0° to +40° C)		
Operating humidity range	10 to 90% relative humidity (non-condensing)		
Operating altitude range	0 to 2,000 meters (6,600 ft) above sea level (without derating output power)		
Storage temperature range	-4° to +140° F (-20° to +60°C)		
Safety			
Agency approvals	Designed to meet UL 60950 (UL/cUL listing pending)		
Warranty			
Two-year limited warranty on parts and labor			

*Note: For continuous product improvement, specifications are subject to change without notice.

Technical Specifications*

[240 V, 7680/9600 VA]

Model	VRP-7700-800A	VRP-9600-800A	VRP-9600-811A
Electrical			
Capacity / (VA)	7680	9600	
Design topology	High-performance PWM voltage regulator operating at 20 kHz		
Voltage correction time	8 ms (½ line cycle)		
AC Input			
Input voltage range	240 V ± 20% (192 – 288 V)		
Frequency	50/60 Hz ± 5 %		
Input circuit breaker rating	40 A	50 A	
AC input connector	Hard-wired		NEMA 6-50P
Surge protection	Three-stage surge protector protects both the VRP and connected equipment from surges & spikes		
AC Output			
Output voltage	240 V ± 3%		
Power efficiency	97% typical (for load of 50 to 100%)		
Maximum rated output current	32.0 A	40.0 A	
System status indicator	Green LED ON-Normal operation - Amber LED ON-Bypass operation Red LED ON-Fault		
Output connector	Hard-wired		NEMA 6-50R
Physical			
Dimension (W x H x D)	14.5" (368 mm) x 8.9" (226 mm) x 19.8" (502 mm)		
Weight	86 lbs (39.0 kg)	104 lbs (47.2 kg)	
Wall / floor mounting kit	MK-8000C		
Max wire size (hard-wired)	8 AWG (10 mm ²)	8 AWG (10 mm ²)	Not applicable
Environmental			
Operating temperature range	32° to +104° F (0° to +40° C)		
Operating humidity range	10 to 90% relative humidity (non-condensing)		
Operating altitude range	0 to 2,000 meters (6,600 ft) above sea level (without derating output power)		
Storage temperature range	-4° to +140° F (-20° to +60°C)		
Safety			
Agency approvals	Designed to meet UL 60950 (UL/cUL listing pending)		
Warranty			
Two-year limited warranty on parts and labor			

*Note: For continuous product improvement, specifications are subject to change without notice.

Technical Specifications* [240 V, 15360/17280/19200 VA]

Model	VRP-15400-500A	VRP-17300-500A	VRP-19200-800A
Electrical			
Capacity / (VA)	15360	17280	19200
Design topology	High-performance PWM voltage regulator operating at 20 kHz		
Voltage correction time	8 ms (½ line cycle)		
AC Input			
Input voltage range	240 V ± 20% (192 – 288 V)		
Frequency	50/60 Hz ± 5 %		
Input circuit breaker rating	80 A	90 A	100 A
AC input connector	Hard-wired		
Surge protection	Three-stage surge protector protects both the VRP and connected equipment from surges & spikes		
AC Output			
Output voltage	240 V ± 3%		
Power efficiency	97% typical (for load of 50 to 100%)		
Maximum rated output current	64.0 A	72.0 A	80.0 A
System status indicator	Green LED ON-Normal operation - Amber LED ON-Bypass operation Red LED ON-Fault		
Output connector	Hard-wired		
Physical			
Dimension (W x H x D)	14.5" (368 mm) x 8.9" (226 mm) x 19.8" (502 mm)		
Weight	116 lbs (52.6 kg)	118 lbs (53.5 kg)	127 lbs (57.6 kg)
Wall / floor mounting kit	MK-8000C		
Max wire size (hard-wired)	2 AWG (35 mm ²)		
Environmental			
Operating temperature range	32° to +104° F (0° to +40° C)		
Operating humidity range	10 to 90% relative humidity (non-condensing)		
Operating altitude range	0 to 2,000 meters (6,600 ft) above sea level (without derating output power)		
Storage temperature range	-4° to +140° F (-20° to +60°C)		
Safety			
Agency approvals	Designed to meet UL 60950 (UL/cUL listing pending)		
Warranty			
Two-year limited warranty on parts and labor			

*Note: For continuous product improvement, specifications are subject to change without notice.





















Technical Specifications*

[240 V, 36096 VA]

Model	VRP-36100-800A
Electrical	
Capacity / (VA)	36096
Design topology	High-performance PWM voltage regulator operating at 20 kHz
Voltage correction time	8 ms (½ line cycle)
AC Input	
Input voltage range	240 V ± 20% (192 – 288 V)
Frequency	50/60 Hz ± 5 %
Input circuit breaker rating	None
AC input connector	Hard-wired
Surge protection	Three-stage surge protector protects both the VRP and connected equipment from surges & spikes
AC Output	
Output voltage	240 V ± 3%
Power efficiency	97% typical (for load of 50 to 100%)
Maximum rated output current	150.4 A
System status indicator	Green LED ON-Normal operation - Amber LED ON-Bypass operation Red LED ON-Fault
Output connector	Hard-wired
Physical	
Dimension (W x H x D)	24.0" (610 mm) x 24.6" (625 mm) x 24.0" (610 mm)
Weight	355 lbs (161.0 kg)
Wall / floor mounting kit	Not applicable
Max wire size (hard-wired)	4/0 AWG (120 mm ²)
Environmental	
Operating temperature range	32° to +104° F (0° to +40° C)
Operating humidity range	10 to 90% relative humidity (non-condensing)
Operating altitude range	0 to 2,000 meters (6,600 ft) above sea level (without derating output power)
Storage temperature range	-4° to +140° F (-20° to +60°C)
Safety	
Agency approvals	Designed to meet UL 60950 (UL/cUL listing pending)
Warranty	
Two-year limited warranty on parts and labor	

*Note: For continuous product improvement, specifications are subject to change without notice.

Table A: Connector types

NEMA straight blade	 NEMA 5-15	 NEMA 5-20	 NEMA 5-30	 NEMA 5-50
	 NEMA 6-15	 NEMA 6-20	 NEMA 6-30	 NEMA 6-50
NEMA twist lock	 NEMA L5-15	 NEMA L5-20	 NEMA L5-30	
	 NEMA L6-15	 NEMA L6-20	 NEMA L6-30	
IEC 60320	 IEC 60320 C14	 IEC 60320 C20		
Schuko	 CEE 7/4			
UK	 BS 1363			
AS/NZS	 3112 15A	 3112 20A	 3112 32A	

Dimensions

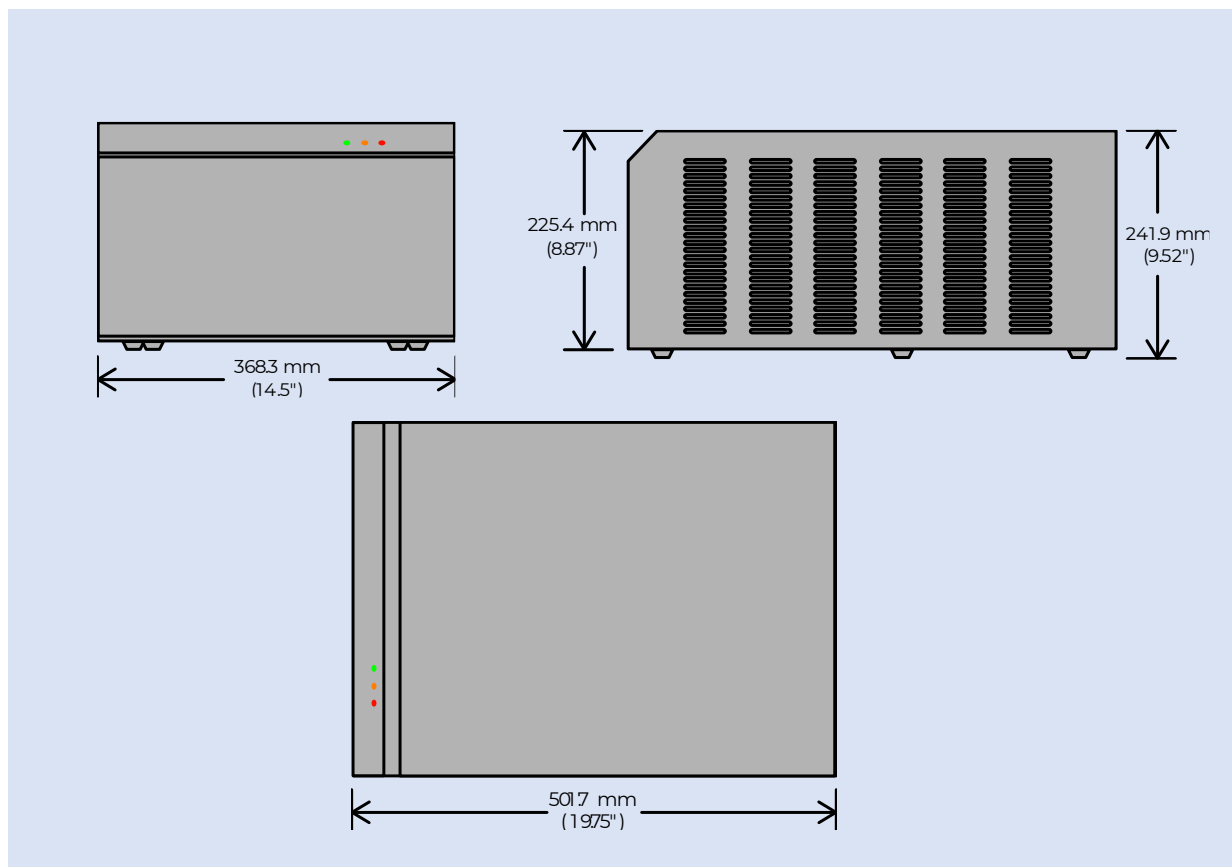
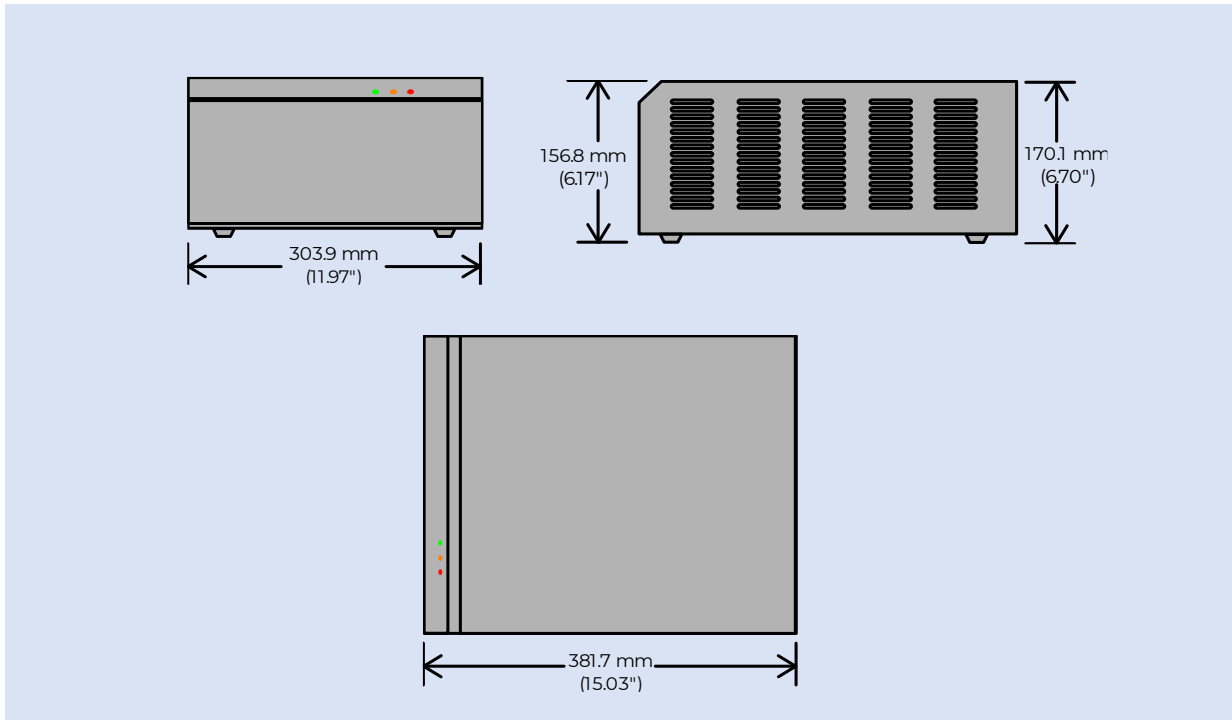

Dimensions

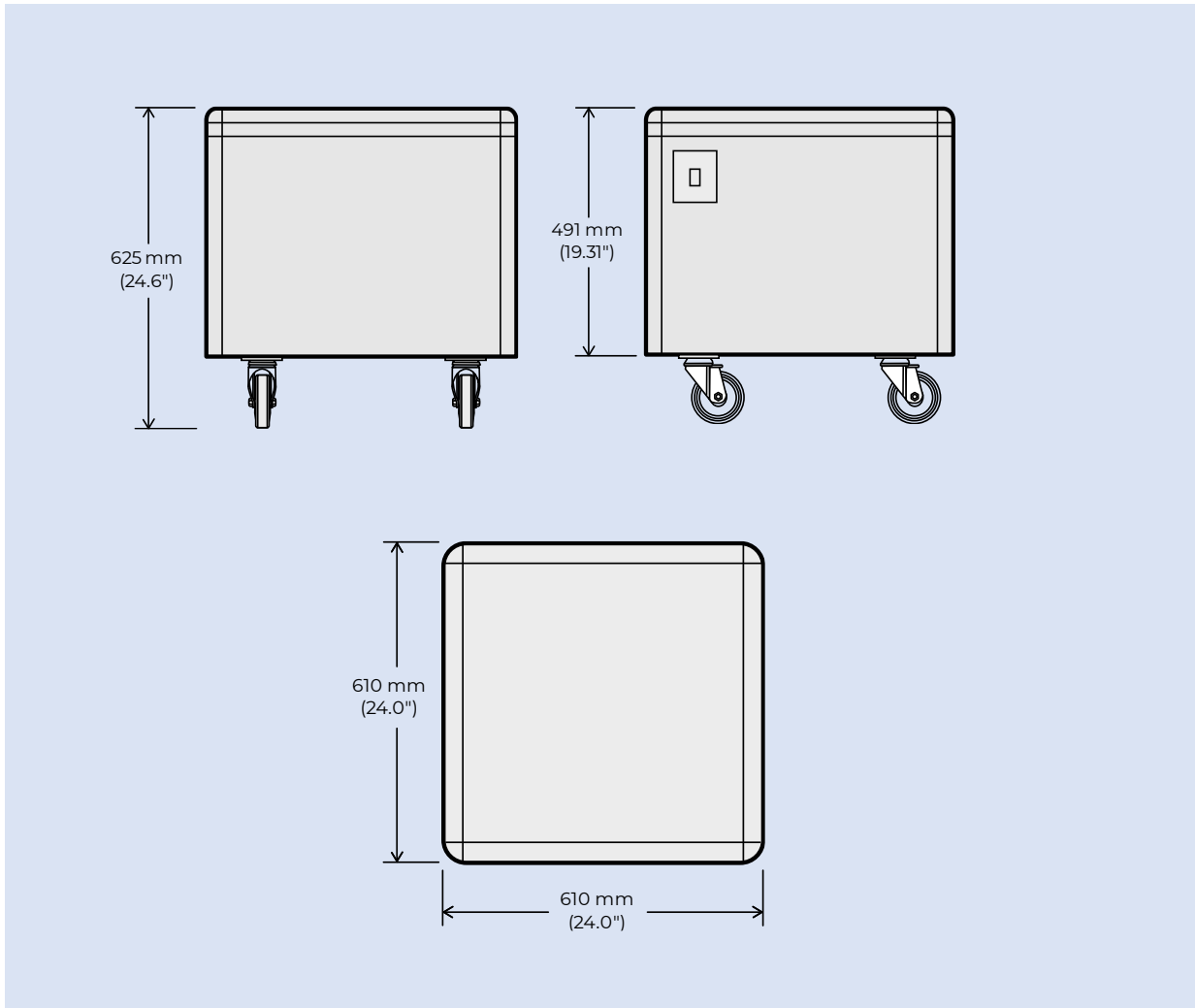

© Copyright 2022, TSI Power Corporation.



TSI Power Corporation

| 1103 W Pierce Avenue, Antigo, WI 54409 USA |
| Tel: + 1-715-623-0636 (US) / + 65-9842-6601(Asia) |
| sales@tsipower.com | www.tsipower.com |